

M20W Handheld Thermography Camera



HIKMICRO M20W handheld thermography camera is specially designed for professional inspections of large objects where a wider FOV captures more of the scene in one picture. It's equipped with a 256 × 192 resolution thermal detector, 50° × 37.2° fixed focus lens, and an 8 MP resolution visual camera. The high resolution 3.5-inch touch screen displays crisp, clear images and streamlines camera operations. Imaging modes include thermal, visual, picture in a picture of the optical and thermal view, and fusion of both channels. The M20W quickly identifies potential faults and quantifies the impact with accurate temperature measurement, provides detailed documentation to complete your inspections efficiently.

Key Feature

- High sensitivity thermal module with 256 × 192 resolution
- Supports multiple palettes
- High quality optical module with 8 MP resolution
- Bi-spectrum image fusion, picture-in-picture preview
- Wide temperature measurement range: -20°C to 550°C
- High temperature measurement accuracy: Max. ($\pm 2^{\circ}\text{C}/3.6^{\circ}\text{F}$, $\pm 2\%$), for ambient temperature 15°C to 35°C (59°F to 95°F) and object temperature above 0°C (32°F)
- High-calibre 640 × 480 resolution 3.5" LCD touch display
- Long-distance laser light supplement for thermography targets
- LED light supplement makes the device a torch in required scenarios
- Supports 1×, 2×, 4× and 8× digital continuous zoom
- Support remote album access, download and quick report with APP.

▪ Specification

| Infrared Image | |
|--------------------------------|---|
| IR Resolution | 256 × 192 (49, 152 pixels) |
| NETD | < 40 mK (@ 25°C, F# = 1.0) |
| Image Frequency | 25 Hz |
| Detector Pitch | 12 μm |
| Spectral Range | 7.5 μm to 14 μm |
| Focal Length | 3.6 mm |
| F-number | F1.0 |
| Field of View (FOV) | 50° × 37.2° |
| Spatial Resolution (IFOV) | 3.33 mrad |
| Min. Focus Distance | 0.5 m (1.64 ft) |
| Focus Mode | Focus Free |
| Image Display | |
| Visual Camera | 3264 × 2448 (8 MP) |
| Display | 640 × 480 Resolution, 3.5" LCD Touch Screen |
| Screen Brightness | Manual |
| Digital Zoom | 1.0× to 8.0× continuous |
| Color Palettes | White Hot, Black Hot, Rainbow, Ironbow, Red Hot, Fusion, Rain |
| Focus Mode Palette | N/A |
| Color Alarm | N/A |
| Image Modes | Thermal/Visual/Fusion/PIP |
| Measurement and Analysis | |
| Object Temperature Range | -20 °C to 550 °C (-4 °F to 1022 °F) |
| Accuracy | Max. (± 2°C/3.6°F, ± 2%), for the ambient temp. 15°C to 35°C (59°F to 95°F) and object temp. above 0°C (32°F) |
| Measurement Tools | Center Spot, Hot Spot, Cold Spot User-definable: 3 spots, 1 line and 3 rectangles. |
| Level and Span Mode | Auto/Manual/1-Tap Touch-screen |
| Data Storage and Communication | |
| Storage Media | Removable 16 GB Micro SD Card |
| Image Storage Capacity | Approx. 60,000 Images |
| Annotations | Voice note: max. 60 seconds; Text note: max. 200 characters |
| Video Storage Capacity | Approx. 15 hours |
| Video File Format | MP4 video and radiometric video |
| General | |
| Wi-Fi | 802.11 b/g/n (2.4 GHz and 5 GHz) |
| Bluetooth | Bluetooth 4.2 |
| USB Interface | USB Type-C |
| LED Light | Yes |
| Laser | Yes, Class II, Wavelength: 635 nm; Power: < 1 mW |
| Battery Type | Interchangeable and rechargeable Li-ion battery |
| Battery Operating Time | Approx. 6 hours |
| Battery Charging Time | Approx. 4 hours fully charged |

| | |
|---------------------------|--|
| Protection Level | IP54 |
| Drop Test Height | 2 m (6.56 ft) |
| Safety | IEC 61010-1 |
| EMC | EN55032, EN50130-4, EN61000-3-3 |
| Vibration | 0.03 g ² /Hz (3.8 g), 2.5 g IEC 60068-2-6 |
| Shock | 25 g, IEC 68-2-29 |
| Working Temperature Range | -10°C to 50°C (-4°F to 122°F) |
| Storage Temperature Range | -20°C to 70°C (-4°F to 158°F) |
| Relative Humidity | < 95% non-condensing |
| Weight | Approx. 660g (1.46 lb) |
| Dimension | 244 mm × 100 mm × 104 mm (9.6" × 3.9" × 4.1") |
| Tripod Mounting | UNC ¼"-20 |

▪ Available Model

M20W

▪ Dimension

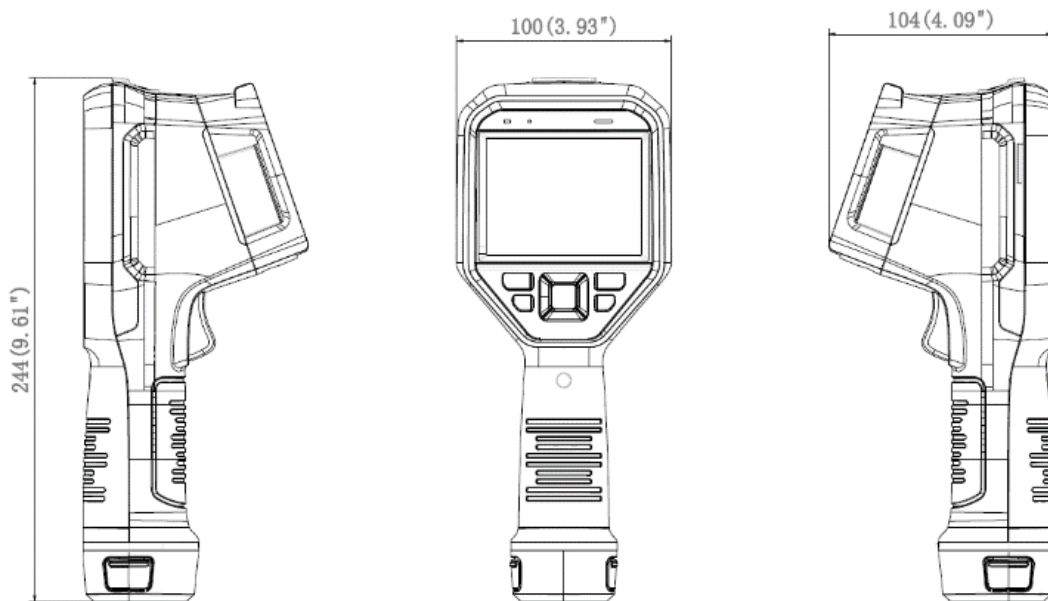

Unit: mm [inch]

▪ Packing List

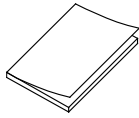

QSG (× 1)

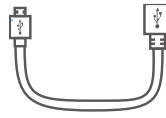

USB 2.0 A to USB Type-C Cable (× 1)



Power Supply for Battery Charger (× 1)

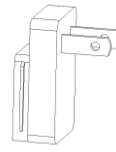

International Use Plugs (US/EU/UK/AU) for Power Supply

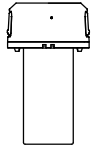

Battery (× 2)

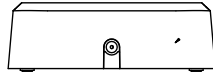

Two-bay Battery Charger (× 1)

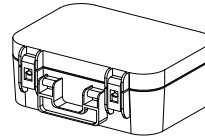

Hard Carrying Case (× 1)

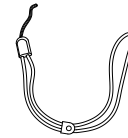

Wrist Strap (× 1)

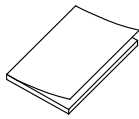

Calibration Certificate (× 1)

▪ Accessory

▪ Optional



E097-13-1S1P26650



HM-5202ZC



HM-SP01-POUCH



HM-2925ZJ-TM01-BRACKET

COMPLIANCE NOTICE: The thermal series products might be subject to export controls in various countries or regions, including without limitation, the United States, European Union, United Kingdom and/or other member countries of the Wassenaar Arrangement. Please consult your professional legal or compliance expert or local government authorities for any necessary export license requirements if you intend to transfer, export, re-export the thermal series products between different countries.

